



TUF-RTX3060TI-08G-GAMING

BUILT TUF

ASUS Innovations

NV Features

- **NVIDIA Ampere Streaming Multiprocessors**
The building blocks for the world's fastest, most efficient GPU, the all-new Ampere SM brings 2X the FP32 throughput and improved power efficiency.
- **2nd Generation RT Cores**
Experience 2X the throughput of 1st gen RT Cores, plus concurrent RT and shading for a whole new level of ray tracing performance.
- **3rd Generation Tensor Cores**
Get up to 2X the throughput with structural sparsity and advanced AI algorithms such as DLSS. Now with support for up to 8K resolution, these cores deliver a massive boost in game performance and all-new AI capabilities.

Fresh Shroud

A new all-aluminum shroud adds a robust flair to TUF builds. The top-side RGB element can be customized with Armoury Crate to sync up with other ASUS components to enable uniform lighting.

Cooling

A MaxContact heat spreader efficiently transfers heat into a new 2.7-slot heatsink. On top, three Axial-tech fans work in tandem to drive air through the entire array, helping to keep temperature under tight control.

illustration update later

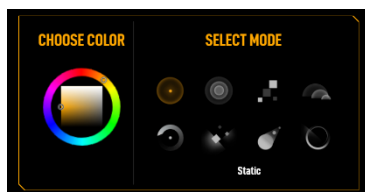



Axial-Tech Upgrades

TUF Gaming cards leverage our tried-and-true Axial-tech fan design, with three fans working in tandem to satisfy the thermal demands of NVIDIA's new high-octane design. The fans rely on dual ball fan bearings to ensure consistent performance and increased longevity compared to sleeve bearings and other bearing types

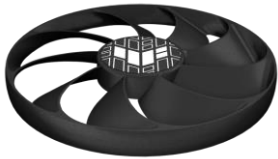

It's Cooler Out Back

Most of the rear is swathed in a protective metal backplate that prominently features a wide vent. The vent allows hot air to escape towards chassis exhaust fans instead of being recycled back into the GPU cooler. Beneath the GPU, a bracket provides consistent mounting pressure between the die and heat spreader. A conveniently placed Dual Bios switch allows customization of the card's default performance profile without software.

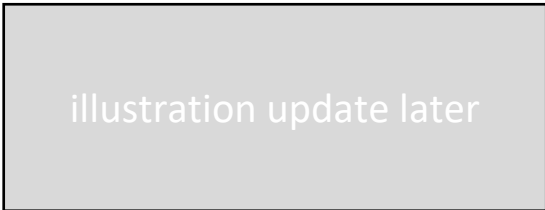

Software Suite

Hardware and software come together to let gamers fully customize and control their gaming experience. GPU Tweak II enables tweaks and monitoring, XSplit offers a robust streaming solution, and wtfast can improve routing to game servers for a more stable gaming connection.



New Directions

The fans have been smartly tuned with a reversed rotation for the center fan, which reduces turbulence, and with a fan-stop mode that kicks in when the GPU temp falls below 55 degrees.



TUF Components

Dual ball fan bearings that stand up to tough conditions more readily than other bearing types and top-shelf capacitors that pass military-grade certification team up to boost product longevity.

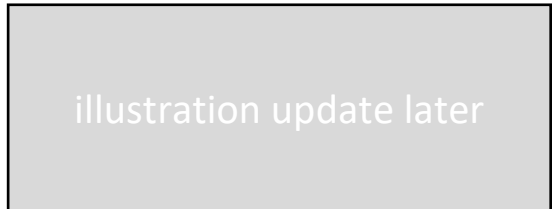

CERTIFICATE OF RELIABILITY



For passing the rigid reliability tests of the following components:

- Capacitor**
 - Thermal Shock Test (MIL-STD-202B Test Method 107G)
 - Moisture Resistance Test (MIL-STD-202G Test Method 1066)
 - Salt Spray Test (MIL-STD-883G method 1009.8)
 - Solderability Test (MIL-STD-2020 208H Test Method)
 - Solder Bath Test (MIL-STD-202G-210G Test Method)
 - Vibration Test (MIL-STD-202G Method 201A)
 - Mechanical Shock Test (MIL-STD-202G Method 213B Condition D)
- Choke**
 - Vibration Test (MIL-STD-810F Method 514)
 - Temperature Cycling Test (MIL-STD-810F Method 501/502)
- MOSFETs**
 - Thermal Shock Test (MIL-STD-883G 1011.9)
 - Vibration Test (MIL-STD-883 Method 20072 Condition A)
 - Mechanical Shock Test (MIL-STD-883G2002.4)

Visit the ASUS website at www.asus.com for the test report.

Testing laboratory: Integrated Service Technology, is accredited by:



ISO/IEC 17025 certificate of independent test laboratory approval
Certificate No. 118991
ISO 17025 accredited in respect of laboratory in approved by TAF
Certificate No. L2935-09021
ISO 9001 certificate is approved by TÜV CERT certification body of TÜV NORD Cert GmbH



ASUS
IN SEARCH OF INCREDIBLE



ASUS Features

OC
Edition

OC edition

TBD MHz GPU boost clock and TBD memory speed in OC mode for outstanding gaming experience.

8GB
GDDR6
Memory

8GB GDDR6 Memory

On-board memory for the best gaming experience & the best resolution.

0dB
FAN
Silent Gaming

0dB Technology

An advanced controller brings fans to a standstill below 55 Celsius, letting you enjoy light gaming in relative silence.

I/O Specifications

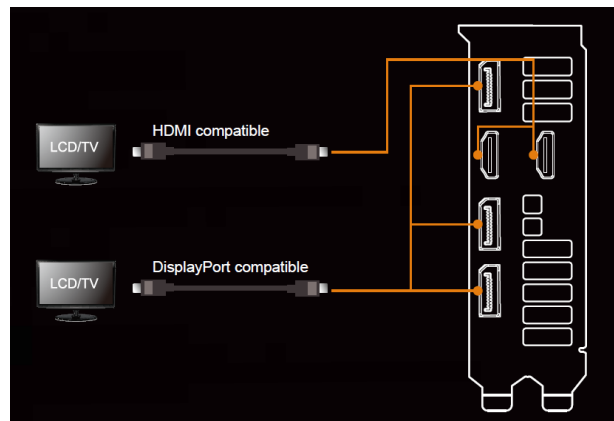

NV Features

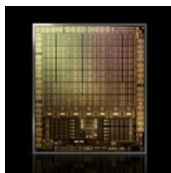

NVIDIA AMPERE ARCHITECTURE

The all-new NVIDIA Ampere architecture delivers the ultimate play, featuring advanced 2nd generation Ray Tracing Cores and 3rd generation Tensor Cores with greater throughput.

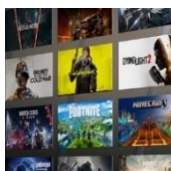

RTX. IT'S ON.

Experience today's biggest blockbusters like never before with the visual fidelity of real-time ray tracing and the ultimate performance of AI-powered DLSS

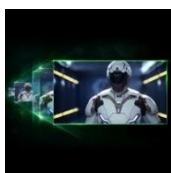

DLSS AI ACCELERATION

NVIDIA DLSS is groundbreaking AI rendering that boosts frame rates with uncompromised image quality using the dedicated AI processing Tensor Cores on GeForce RTX. This gives you the performance headroom to crank up settings and resolutions for an incredible visual experience. The AI revolution has come to gaming.

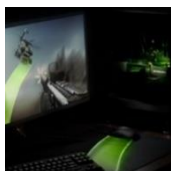

VICTORY MEASURED IN MILLISECONDS

NVIDIA Reflex delivers the ultimate competitive advantage. The lowest latency. The best responsiveness. Powered by GeForce RTX 30 Series GPUs and NVIDIA® G-SYNC® monitors. Acquire targets faster, react quicker, and increase aim precision through a revolutionary suite of technologies to measure and optimize system latency for competitive games.



UP YOUR CREATIVE GAME

Take your creative projects to a new level with GeForce RTX 30 Series GPUs. Delivering AI-acceleration in top creative apps. Backed by the NVIDIA Studio platform of dedicated drivers and exclusive tools. And built to perform in record time. Whether you're rendering complex 3D scenes, editing 8K video, or livestreaming with the best encoding and image quality, GeForce RTX GPUs give you the performance to create your best.



DIRECTX 12 ULTIMATE

Developers can now add even more amazing graphics effects to Microsoft Windows-based PC games. GeForce RTX graphics cards deliver advanced DX12 features like ray tracing and variable rate shading, bringing games to life with ultra-realistic visual effects and faster frame rates.



Specifications

Model Name	TUF-RTX3060TI-O8G-GAMING
Graphics Engine	NVIDIA GeForce RTX™ 3060TI
CUDA cores	TBD
OpenGL®	OpenGL® 4.6
Engine Clock	OC Mode : TBD MHz (Boost Clock) Gaming Mode : TBD MHz (Boost Clock)
Memory Interface	256-bit
Video Memory	8GB GDDR6
Memory Clock	14 Gbps
Power Connector	1 x 8-pin
I/O	2 x Native HDMI 2.1 3 x Native DisplayPort 1.4a
HDCP Compliant	HDCP 2.3
Digital Max. Resolution	7680 x 4320
Maximum Display Support	4
NVLink/Crossfire Support	N/A
Recommended PSU	TBD W
Bus Standard	PCIe 4.0
Package Contents	1 x TUF Certificate of Reliability 1 x Collection Card 1 x Speedsetup Manual
Software Bundled	ASUS GPU Tweak II & Driver (please download all software from the support site)
Slot	2.7 slot
Dimension	
Card Size (mm/inch)	301 x 143 x 44 mm 11.85 x 5.63 x 1.73 inches
Color Box (mm)	405 x 233 x 88.5 mm
Weight	
Single Card (KG)	1.14 KG
Product Weight (with packing) (KG)	1.743 KG
Note	* All specifications are subject to change without notice. Please check with your supplier for exact offers. Products may not be available in all markets. If you do not use the latest and current specifications of ASUS products, you shall be liable for all loss and damage claimed by third party to ASUS based on false advertising or any other issues caused from using false specifications of ASUS products.