



Alienware Wireless Gaming Headset AW988

User's Guide

Regulatory Model: AW988

A L I E N W A R E™ 

Notes, cautions, and warnings

-  **NOTE:** A NOTE indicates important information that helps you make better use of your computer.
-  **CAUTION:** A CAUTION indicates potential damage to hardware or loss of data if instructions are not followed.
-  **WARNING:** A WARNING indicates a potential for property damage, personal injury, or death.

Copyright © 2018 - 2020 Dell Inc. or its subsidiaries. All rights reserved. Dell, EMC, and other trademarks are trademarks of Dell Inc. or its subsidiaries. Other trademarks may be trademarks of their respective owners.

2020 – 11

Rev. A02

Contents

What's in the box	5
About the headset	6
Setting up your headset on your computer	7
System requirements	7
Connecting the headset to your computer using the USB wireless dongle	7
Configuring the headset on your computer	7
Connecting the headset to your computer or mobile device using the 3.5 mm audio cable (optional)	10
Alienware Command Center	11
Installing Alienware Command Center (AWCC)	11
Charging the headset	12
Battery life	12
Auto power off	12
Using the headset	13
Adjusting the headset	13
Turning on/off your headset	14
Adjusting the main volume	14
Muting/unmuting the microphone	15
Switching between the audio presets	16
Adjusting the chat balance	17
Storing the USB wireless dongle in the headset	17
Replacing the earcup cushions	18

Troubleshooting19

Specifications 22

 General22

 Physical characteristics22

 Environmental22

Warranty information 23

 Limited warranty and return policies23

 For U.S. customers:.23

 For European, Middle Eastern and African customers: . . .23

 For non-U.S. customers:23

What's in the box

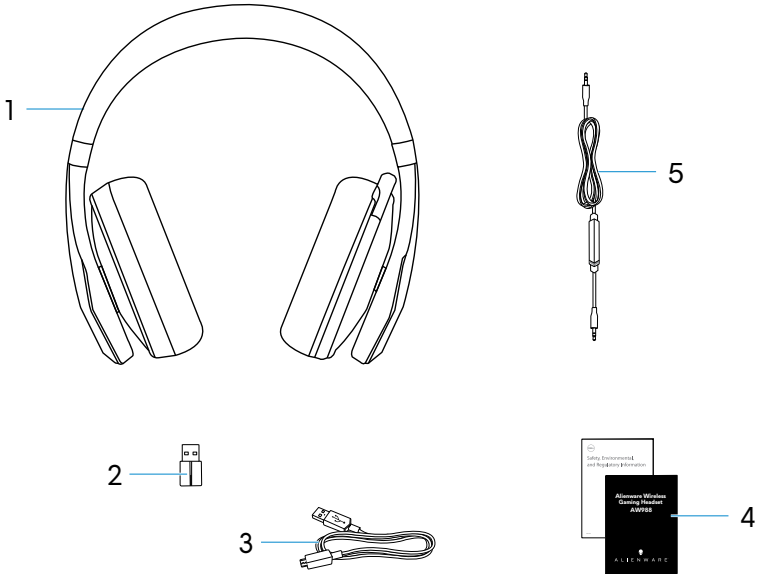

- | | | | |
|---|---|---|---------------------|
| 1 | Alienware Wireless Gaming Headset—AW988 | 2 | USB wireless dongle |
| 3 | USB cable for battery charging | 4 | Documents |
| 5 | Audio cable (3.5 mm) | | |

NOTE: The documents shipped with the headset may vary based on your region.

About the headset

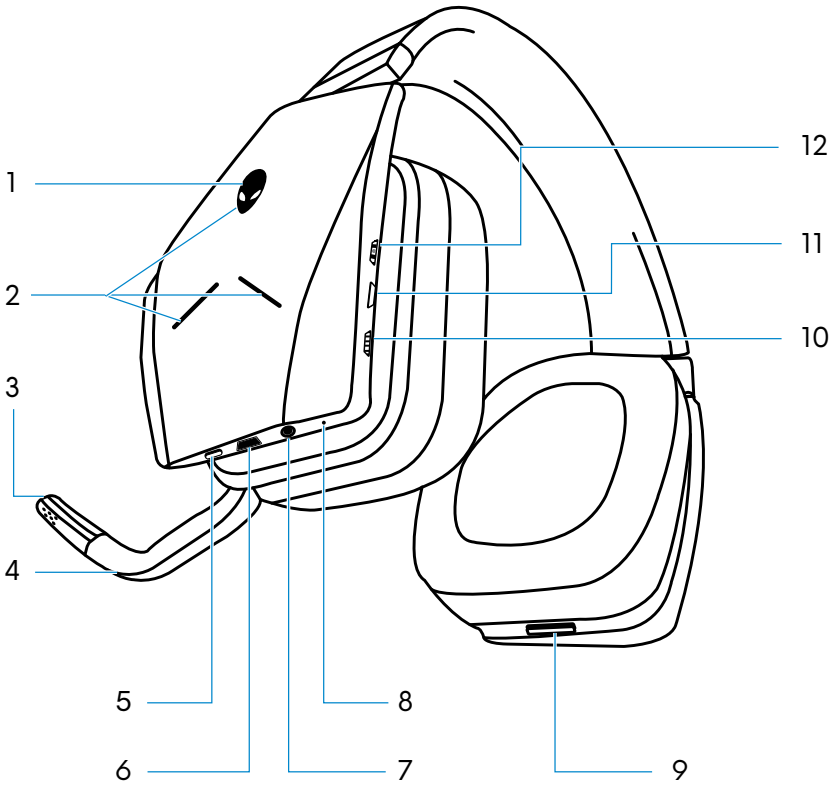

1	Power button	2	Alienware two zones lighting
3	Microphone mute indicator	4	Retractable boom mic
5	Audio preset button	6	Micro-USB charging port
7	3.5 mm audio port	8	Battery status indicator
9	USB wireless dongle storage slot	10	Main volume control
11	Microphone mute button	12	Game/chat volume mixer control

Setting up your headset on your computer

System requirements

- One USB port for USB wireless dongle
- One USB port for charging (optional)
- Microsoft Windows 10 version 16299 or later

Connecting the headset to your computer using the USB wireless dongle

Connect the USB wireless dongle to the USB port on your computer. The headset and the USB wireless dongle are pre-paired.

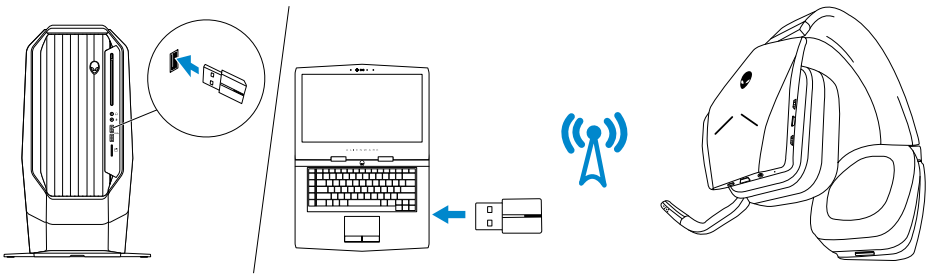

Configuring the headset on your computer

To use your headset for gaming or to listen to music from your computer, it has to be selected as the default playback device and the default recording device in Windows Audio Settings.

- 1 On Windows toolbar, right-click the speaker icon to access the Windows Audio Settings. The **Sound** dialog box appears.

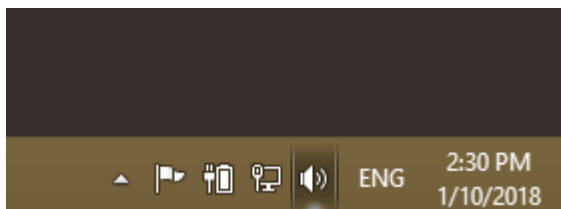

- 2 Click the **Playback** tab and set the following:
- Alienware AW988 Game as the Default Playback device.
 - Alienware AW988 Chat as the Default Communication device.

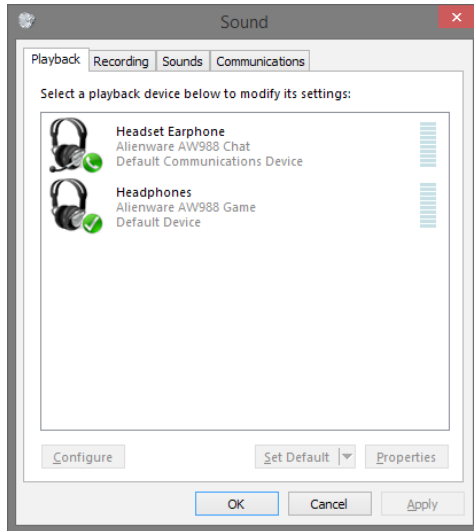

- 3 Click the **Recording** tab, set the Alienware AW988 Chat as the Default Device.

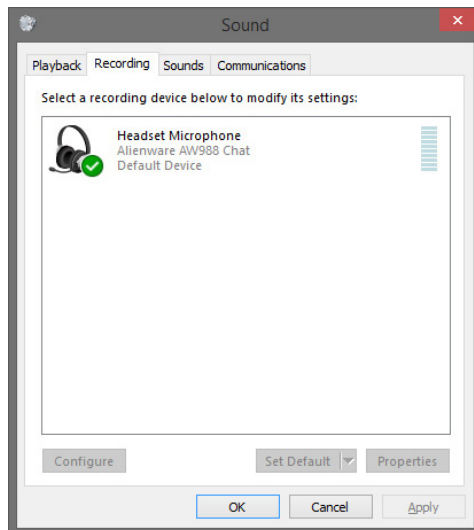

4 Click the **Communications** tab, select **Do nothing**.

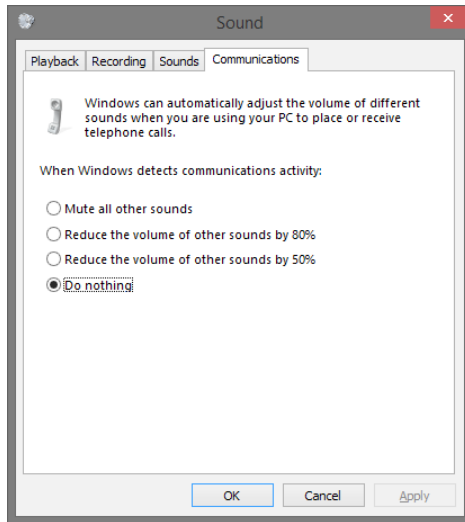

Connecting the headset to your computer or mobile device using the 3.5 mm audio cable (optional)

Connect one end of the audio cable to the 3.5 mm audio port on your headset, and connect the other end to the audio/headset port on your computer or mobile device.

The headset speakers and the microphone on the cable will function even when the headset is powered off, as long as the headset is connected to a 3.5 mm audio port. The buttons and LEDs will not function when powered off.

NOTE: Audio preset is not supported for 3.5 mm audio port.

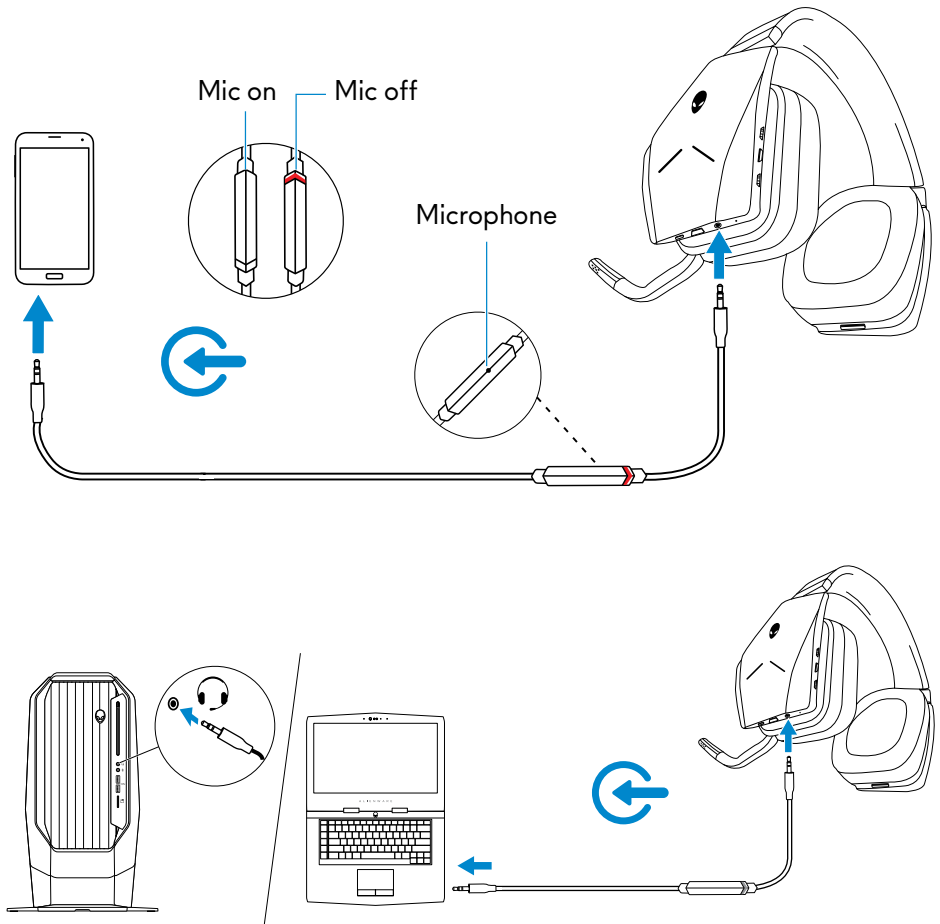

Alienware Command Center

Installing Alienware Command Center (AWCC)

Alienware Command Center (AWCC) provides a single interface to transform your Windows computer into an enhanced gaming environment. To use the AWCC features, uninstall Alienware Headset Center (AWHC) if you have already installed AWHC on your computer.

You need to install Alienware Command Center (AWCC) to configure the features available in Alienware Wireless Gaming Headset AW988.

Before installing AWCC on your computer, ensure that your computer is connected to Internet. If your computer is preinstalled with AWCC 5.0 or later, you can configure your Alienware gaming headset through FX available in AWCC.

If your computer is not preinstalled with AWCC 5.0 or later, install AWCC through Windows Update or from the Dell Support website at www.dell.com/support. AWCC requires Windows 10 version 16299 or later.

Installing AWCC through Windows Update

- 1 Connect your Alienware USB wireless dongle to your computer through USB port. The AWCC application is downloaded and installed automatically. AWCC installation may take up to 10 minutes to complete.
- 2 Go to the program folder to ensure that the AWCC installation is complete.
- 3 Launch AWCC. Perform the following steps to download additional software components:
 - In the **Settings** window, click **Windows Update**, and then click **Check for updates** to check the Alienware driver update progress.
 - If the driver update is not responding on your computer, install AWCC from the Dell Support website.

Installing AWCC from the Dell Support website

- 1 Download the latest version of the following applications at www.dell.com/support/drivers.
 - Alienware Command Center
 - Alienware Gaming Headset driver
- 2 Go to the folder where you saved the setup files.
- 3 Double-click the setup file and follow the on-screen instructions to install the application.

 **NOTE: You can customize the headset feature and lighting effects by using the Alienware Command Center.**

Charging the headset

To charge the headset, connect one end of the USB cable to the micro-USB port on your headset, and connect the other end to the USB port on your computer.

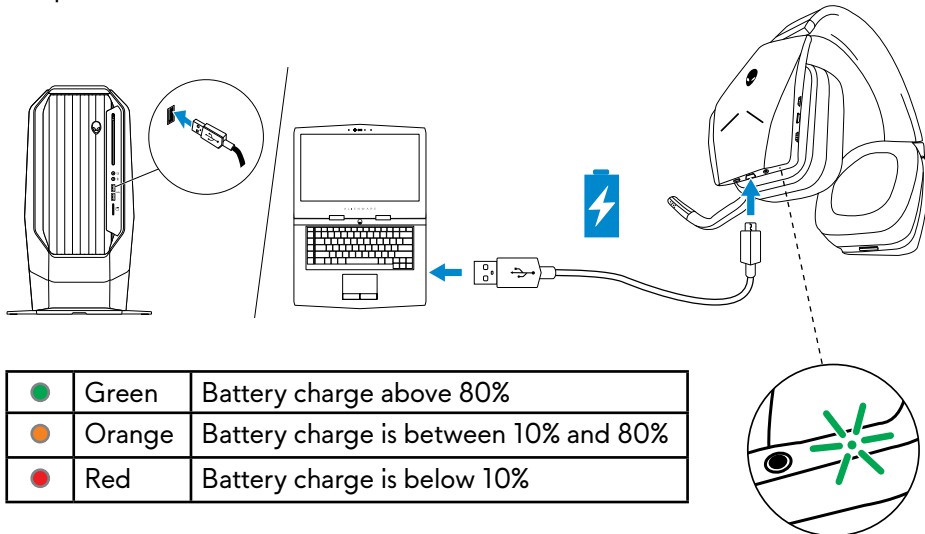

● Green	Green	Battery charge above 80%
● Orange	Orange	Battery charge is between 10% and 80%
● Red	Red	Battery charge is below 10%

Battery life

The headset battery can last up to 14 hours of gaming/audio playback (with the lights turned off). It can last up to 8 hours when the lights are turned on. The complete charging of battery may take up to 2.5 hours.

When the headset is not charging, the battery status light indicates the charge remaining on the battery.

● Off	Off	Above 10% battery
● Red	Red	Below 10% battery (low or critical)

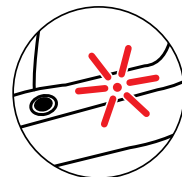

Auto power off

When the wireless connection between the headset and the USB wireless dongle is lost (either the computer is powered off or the USB wireless dongle is removed from the USB port), the headset will automatically turn off after 30 minutes. You can adjust the timer using the software. To turn the headset on, press the Power button.

Using the headset

Adjusting the headset

Adjust the headband to find the optimal fit for your head. When using the retractable microphone, position it approximately two centimeters away from your mouth.

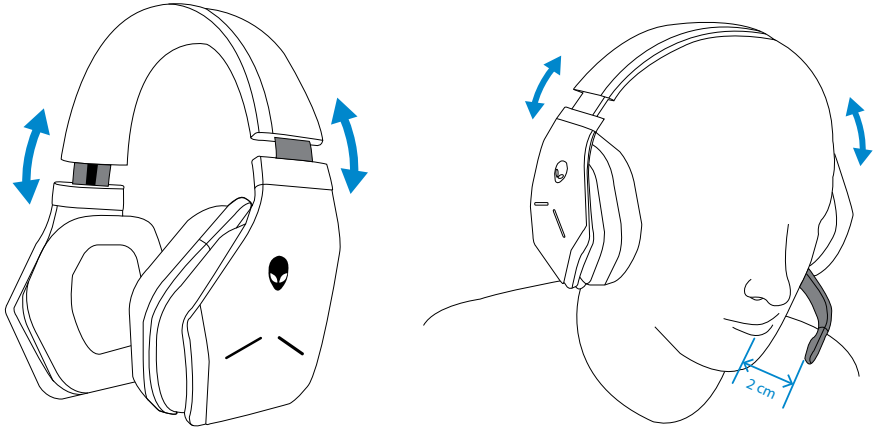

The earcups can be rotated to wear the headset around the neck comfortably, or for easier storage.

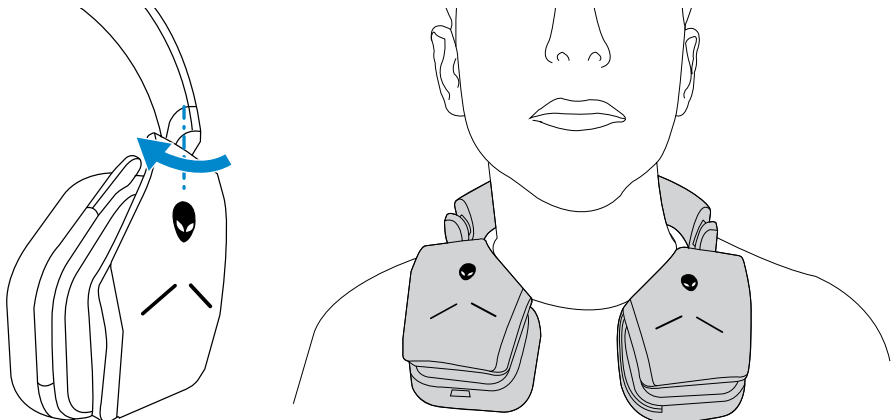

Turning on/off your headset

Press the power button on the left earcup to turn the headset on. Press and hold the power button for 3 seconds to turn the headset off.

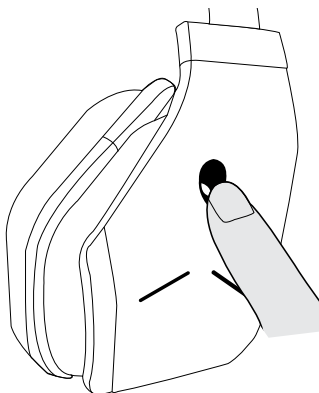

Adjusting the main volume

Use the main volume control to adjust the speaker volume. Turn the control up to increase the volume, or down to decrease the volume.

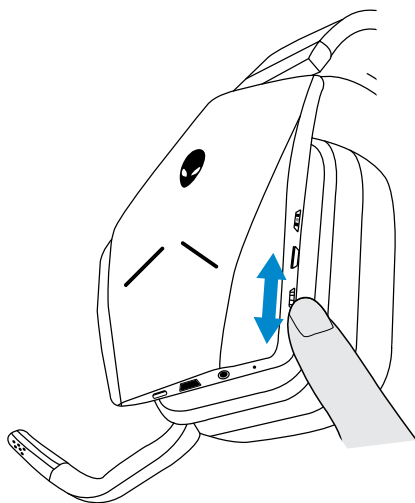

Muting/unmuting the microphone

Use the mute button to mute or unmute the microphone. Alternatively, fold the retractable microphone back into place to mute the microphone, or lower the retractable microphone to unmute the microphone.

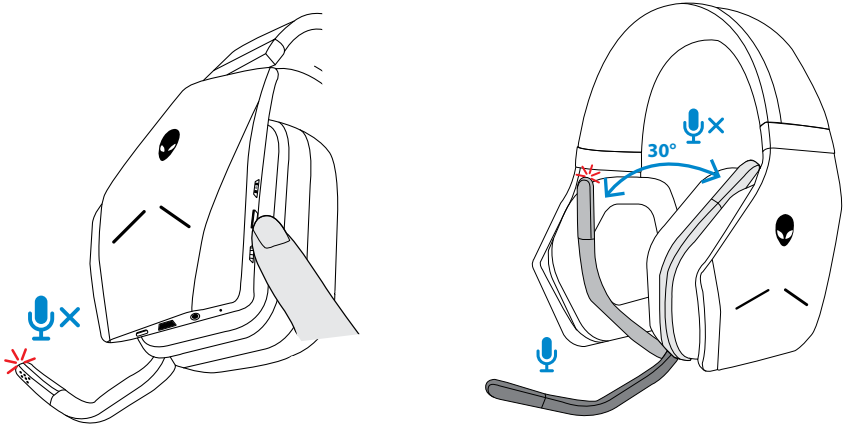

The microphone mute light turns red to indicate the microphone is on mute.

NOTE: You will hear an audio prompt when the retractable microphone is opened or closed.

Switching between the audio presets

Press the Audio preset button to cycle through the available presets.

When the headset software is running, pressing the Audio preset button will cycle through all presets as listed in the software.

When the headset software is not running, pressing the Audio preset button will cycle through Gaming, Music, and Movie presets.

An audible voice prompt is played to indicate the selected preset is activated.

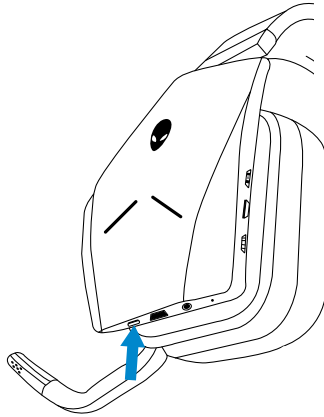

Adjusting the chat balance

Use the Chat balance control to find a preferred balance between chat audio and game audio.

Turn the control up to focus on the game volume, reducing the chat volume from 100% to 0%. Turn the control down to focus on the chat volume, reducing the game volume from 100% to 0%. Turn the control to the center position, as indicated by the white marker, to set chat and game audio to their original levels.

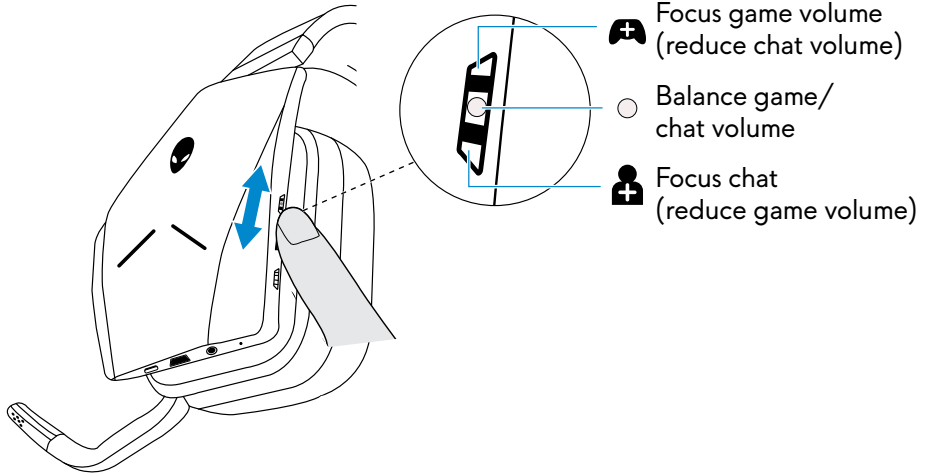

Storing the USB wireless dongle in the headset

The USB wireless dongle can be stored in the USB wireless dongle storage slot.

To secure the wireless dongle, insert it into the slot as shown and push until you hear an audible click sound.

To remove the wireless dongle, push it inside the headset until you hear an audible click, then remove your finger. The wireless dongle will pop out of storage slot and is held in place by a magnet. Pull the USB wireless dongle out of the slot to use it.

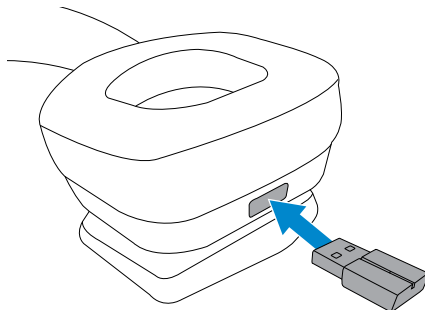

Replacing the earcup cushions

The earcup cushions can be removed and replaced, if necessary. To order new earcup cushions go to www.dell.com.

To remove the cushion, hold the cushion firmly and rotate clockwise (left cushion) or counter-clockwise (right cushion), and then pull the cushion away from the headset.

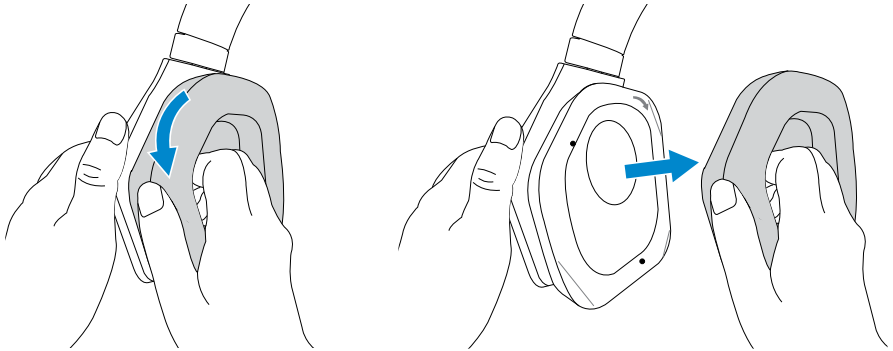

To replace the cushion, fit them around the edges of the earcup firmly and rotate them into position.

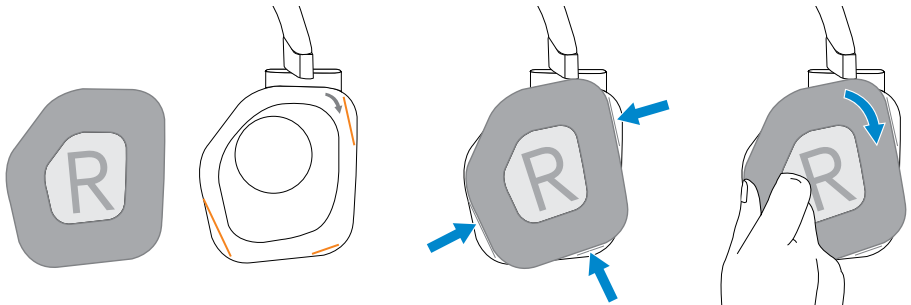

Troubleshooting

Problems

Possible solutions

Headset has no sound

- Ensure that the headset is turned on, and properly connected through the wireless dongle or audio cable.
- Ensure that the audio player is playing music, and that the computer volume and media player volume are on and not muted.
 - Click the volume icon on your computer.
 - Adjust the volume level on the volume bar.
- Check the playback setting on the computer, and ensure that the default device is set to DEVICE NAME.
- Check the headset is within range (12 m) of the wireless dongle (if connected through the wireless dongle).
- Check wireless connection is good (Blue LED on dongle not blinking)

The person on the other end cannot hear me.

- Ensure the microphone is positioned close to the mouth.
 - Ensure the microphone is not muted. The mute light should be off.
 - Ensure the headset is within range (12 m) of the wireless dongle (if connected through the wireless dongle).
 - Ensure that the audio plug end with 3 poles is inserted into the headset port, and the end with 4 poles is inserted into your computer or mobile (if connected through the audio cable).
-

Problems

Possible solutions

Abnormal sound is coming out of the headset

- Check if something is obstructing the headset.
- Adjust the volume level up and down, and check if the abnormal sound changes.
- Ensure that the headset is within range (12 m) of the wireless dongle (if connected through the wireless dongle).
- Ensure that the audio plug is fully inserted into the audio port of the computer or mobile (if connected through the audio cable).

Unbalanced sound in the headset

- Check the computer Volume Balance is set correctly.
 - Right-click the headset icon.
 - Select **Playback devices**.
 - Right-click **Default Playback devices**, and select **Properties**.
 - Select **Levels**, and click **Balance**. Ensure that the L and R values are the same.

Headset lights do not light up

- Ensure that the headset is turned on.
- Open Alienware Control Center, and ensure that the lights are turned on.

Alienware Control Center does not recognize the headset

- Ensure that the headset is turned on.
 - Ensure that the headset is connected to the computer through the wireless dongle.
 - If the problem persists, replug the wireless dongle, or restart Alienware Control Center.
-

Problems

Possible solutions

Wireless range is too short

- Ensure that the wireless dongle is not covered or blocked by metal or electronic objects.
- Try connecting the wireless dongle to the USB port on the side of your computer, rather than the USB port at the back of your computer.
- Ensure that no other USB device is connected adjacent to the wireless dongle.

Microphone picks up too much background noise

- Ensure that the microphone is positioned close to the mouth.
- Open Alienware Control Center, and reduce the microphone volume.

Main volume control, chat balance control, and audio button are not working.

- Connect the headset to a computer using the wireless dongle.
- The volume control, chat balance control, and audio button will not work when the headset is connected through the audio jack.

Microphone mute is not working when connected with audio cable

- Ensure that the microphone mute button on the audio cable is set to MUTE OFF.
 - Ensure that the audio plug end with 3 poles is inserted to the headset port, and the end with 4 poles is inserted to your computer or mobile.
-

Specifications

General

Model number	AW988
USB compliance	USB 2.0 (General and Audio Class specifications)
Supported operating systems	Windows 10 version 16299 or later

Physical characteristics

Weight (headset only)	375 (+/-5) g headset only
Dimensions	Headset 190 mm x 193 mm x 93 mm
Washable item	None (general cleaning with damp cloth)

Environmental

Operating temperature	5°C to 40°C (41°F to 104°F)
Storage temperature	-5°C to 45°C (23°F to 113°F)
Operating humidity	5% to 90% relative humidity

Warranty information

Limited warranty and return policies

The Alienware Wireless Gaming Headset AW988 carries a 2-year limited hardware warranty. If purchased together with a Dell system, it will follow the system warranty.

For U.S. customers:

This purchase and your use of this product are subject to Dell's end user agreement, which you can find at www.Dell.com/terms. This document contains a binding arbitration clause.

For European, Middle Eastern and African customers:

Dell-branded products that are sold and used are subject to applicable national consumer legal rights, the terms of any retailer sale agreement that you have entered into (which will apply between you and the retailer) and Dell's end user contract terms.

Dell may also provide an additional hardware warranty – full details of the Dell end user contract and warranty terms can be found by going to www.Dell.com, select your country from the list at the bottom of the "home" page, and then click the "terms and conditions" link for the end user terms or the "support" link for the warranty terms.

For non-U.S. customers:

Dell-branded products that are sold and used are subject to applicable national consumer legal rights, the terms of any retailer sale agreement that you have entered into (which will apply between you and the retailer) and Dell's warranty terms. Dell may also provide an additional hardware warranty – full details of Dell's warranty terms can be found by going to: www.Dell.com/terms, select your country from the list at the bottom of the "home" page, and then click the "terms and conditions" link or the "support" link for the warranty terms.