

# RT10 SERIES RUGGED TABLET

---

Accessories Guide

---



**Honeywell**

# TABLE OF CONTENTS

- 2 Power and Batteries
- 2 Power Cables / Adapters
- 2 Chargers
- 3 Docks and Cradles
- 3 Keyboards
- 4 Miscellaneous
- 4 Vehicle Mount Parts
- 5 Vehicle Mount Parts (cont.)
- 6 Vehicle Mount Kits

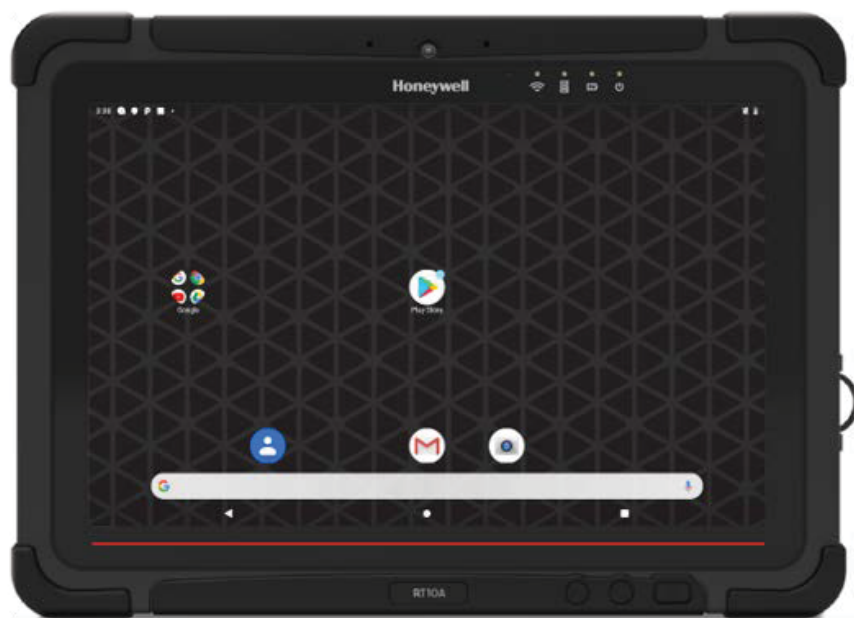

# POWER AND BATTERIES



RT10-PWR

## RT10 Power Supply

Spare power supply. 100–240V AC to 19V DC at 3.42A. Requires country-specific cord.

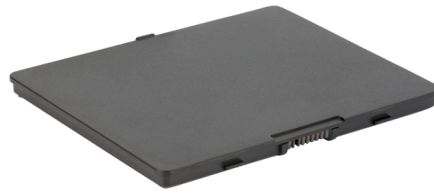

RT10-BAT-STD1

## RT10 Standard Battery

Spare standard battery: 7.7 V, 5140 mAh Li-Polymer battery. 276 g (9.7 oz) weight, 11 mm (0.4 in) thick.



RT10-BAT-EXT1

## RT10 Extended Battery

Spare extended battery. 7.4V, 10280 mAh Li-Polymer battery. 474 g (16.7 oz) weight, 16.5 mm (0.6 in) thick.

# POWER CABLES / ADAPTERS



RT10-PWR-CABLE

## RT10-PWR-CABLE-EU

C6 type power cable, Europe

## RT10-PWR-CABLE-DMK

C6 type power cable, Denmark 3-pin

## RT10-PWR-CABLE-ITA

C6 type power cable, Italy 3-pin

## RT10-PWR-CABLE-UK

C6 type power cable, UK 3-blade

## RT10-PWR-CABLE-SWI

C6 type power cable, Switzerland 3-pin

## RT10-PWR-CABLE-AUS

C6 type power cable, Australia

## RT10-PWR-CABLE-US

C6 type power cable, United States

## RT10-PWR-CABLE-IND

C6 type power cable, India

## RT10-PWR-CABLE-CN

C6 type power cable, China

## RT10-PWR-CABLE-SA

C6 type power cable, South Africa



RT10-VM-POWER-CVRT

Adapter cable to convert Thor VM series power supply connections to the RT10-VD or RT10-VC 3-pin terminal block power input.



RT10-IGNITION-CABLE

## RT10 Ignition Cable

Directs power to RT10-EVC or RT10-EVD Docks on forklifts that do not use separate ignition control (powered directly). If the forklift install uses ignition control, this bypass adapter cable is not required.

# CHARGERS



RT10-BC-2

## RT10 2-Bay Battery Charger

2-bay battery charger for standard or extended batteries. 12–19V DC in power. Standard battery charges in 3 hours, extended battery charges in 6 hours.

**Kit includes:** 1x 2-bay battery charger, 1x 19V AC adapter. Requires country-specific cord.



RT10-MC

## RT10 Vehicle Charger with Cigarette Header

Vehicle charger/cigarette lighter adapter. 11–32V DC in, 19V/3.42A DC out.

# DOCKS AND CRADLES



RT10-CD

### RT10 Office Communications Dock

Desk dock, Supports 19V DC power supply, not included.

**Ports:** 2x USB 2.0 side, 2x USB 2.0 rear, RS-232, 1x RJ45 Ethernet, VGA (note: VGA supports RT10W only), RT10 pogo-pin dock connector.



RT10-VD

### RT10 Vehicle Dock with Power Cable

Vehicle dock, 3-pin terminal block 9–36V power supply. Power adapter cable included. Easy insert and release with key-lock.

**Ports:** 4x USB-A, 1x RS-232, 1x RJ45 Ethernet, 1xGPS antenna, RT10 pogo-pin dock connector. 75 mm x 75 mm (2.95 in x 2.95 in) VESA mount.

**Vibration:** MIL-STD-810G, 5–500 Hz, 2.24G.



RT10-VC

### RT10 Vehicle Cradle

Vehicle cradle – power only. 3-pin terminal block 9–36V power supply. Power adapter cable included.

Easy insert and release with key- lock. RT10 pogo-pin dock connector. 75 mm x 75mm (2.95 in x 2.95 in) VESA mount.

**Vibration:** MIL-STD-810G, 5–500 Hz, 2.24G.



RT10-EVD

### RT10 Enhanced Vehicle Dock

Vehicle dock, VM compatible 10–60V power supply. Easy insert and release with key-lock.

**Ports:** 2x USB-A, 2x RS-232, 1x D-9 USB, 1x D-15 USB, RT10 pogo-pin dock connector, 1x RJ45 Ethernet connector.

75 mm x 75 mm (2.95 in x 2.95 in) VESA mount.

**Vibration:** MIL-STD-810G, 5–500 Hz, 2.24G.



RT10-EVC

### RT10 Enhanced Vehicle Cradle

Vehicle cradle – power only. Vehicle-mount compatible 10–60V power supply. Easy insert and release with key-lock. RT10 pogo-pin dock connector. 75 mm x 75 mm (2.95 in x 2.95 in) VESA mount..

**Vibration:** MIL-STD-810G, 5–500 Hz, 2.24G.



RT10-DD

### RT10 Display Dock

Display dock for connecting to external monitor. Ports: 1x RJ45 Ethernet, 4x USB-A, 1x HDMI, RT10 pogo-pin dock connector. Supports 12–19V power supply and power cord not included.

# KEYBOARDS



9000160KEYBRD

Windows Laptop Style 95 key rugged keyboard with integrated 2 button mouse, DB9M USB Interface.



9000161KEYBRD

### Numeric Keypad

Numeric keypad, 21-key, USB interface; large keys make it ideal for glove use.

# MISCELLANEOUS



RT10-HS-1

### RT10 Hand Strap

Hand strap kit including screws. Adjustable for standard or extended battery sizes.



RT10-SS-1

### RT10 Shoulder Strap

Shoulder strap kit including screws. Adjustable cross-body strap with pad.



RT10-CASE

### RT10 Carrying Case

Carry bag with hand carrier and adjustable shoulder strap. Separate pocket for accessories.



RT10-STY-1

### RT10 Capacitive Stylus with Tether

Replacement capacitive stylus with tether.

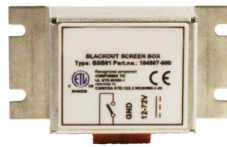

VX89351PWRSPLY

### Screen blanking switch box, universal.

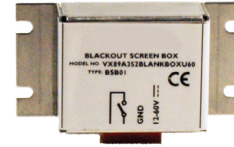

VX89352PWRSPLY

### Screen blanking switch box, for China only.



RT10-CAC - AVAILABLE IN US AND EUROPE ONLY

### RT10 Smart Card Reader

Smart card reader. Snaps on to the back of the tablet.



RT10-SCREEN-FILM1

### Protective screen for RT10, pack of 1. (PET material)



RT10-KEYBD-PLATE

Keyboard adapter for vehicle dock installation. Attaches to vehicle docks.

# VEHICLE MOUNT PARTS



RT10-2012BRKTKIT

### RAM Mount kit, Round base

Medium arm 8.5inch (215 mm) , C-Balls (QTY 2), Mounting plate for keyboard. For mounting to RT10 vehicle docks.

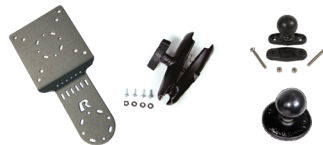

RT10-2015BRKTKIT

### RAM Mount kit, Clamp base

Medium arm 8.5inch (215 mm) , C-Ball, C-Clamp, Mounting plate for keyboard. For mounting to forklift pipe.



RT10-MNT-RAM-C

75x75mm VESA Plate with 1.5" diameter rubber ball "C" size.

# VEHICLE MOUNT PARTS, Continued



RT10-MNT-RAM

### RT10 Mounting Kit

Connects to a RAM mount 75x75mm VESA Plate with 2.25" diameter rubber ball "D" size..



RT10-MNT-VS

### RT10 VESA Mount

75 mm x 75 mm (2.95 in x 2.95 in) VESA mount kit. SGCC-grade steel. Includes 5x M4 6 mm (0.2 in) round screws, 5x M3 5 mm (0.2 in) round screws.



VX89A030RAMBALL

Ball, "D"-size 57.15 mm (2.25 in), round 93.47 mm (3.68 in) base, typically mounts to vehicle.



VX89A031RAMBALL

Ball, "D"-size 57.15 mm (2.25 in), flat 63.5 mm (2.5 in) clamp base, typically mounts to vehicle.



VX89A032RAMBALL

Ball, "D"-size 57.15 mm (2.25 in), 120.65 mm (4.75 in) square base, typically mounts to vehicle.



VX89A503RAMARM

RAM long arm, 330 mm (13 in) for "D"-size 57.15 mm (2.25 in) balls to vehicle.



VX89535PLATE

Mounting plate, truckside for attaching one "D"-size ball. No ball included.



9000033PLATE

Backup plate (set of 2). Note: Hardware included. These two plates can be mounted on each side of the forklift roof. Various RAM balls can be attached to these plates to avoid having to drill mounting holes or weld to the forklift.



VX89A033RAMBALL

Ball, "D"-size 57.15 mm (2.25 in), clamp base for 31.75 mm (1.25 in) to 47.63 mm (1.875 in) pipe mount, typically mounts to vehicle.



VX89A041RAMBALL

Ball, "C"-size 38.1 mm (1.5 in), 63.5 mm (2.5 in) round base.



VX89A504RAMARM

RAM medium arm, 145 mm (5.7 in), "C"-size 38.1 mm (1.5 in) balls.



VX89A504RAMARM

RAM medium arm, 145 mm (5.7 in), "C"-size 38.1 mm (1.5 in) balls.

# VEHICLE MOUNT PARTS, Continued



VX89A501RAMARM

**RAM medium arm, 215 mm (8.5 in)**  
for "D"- size 57.15 mm (2.25 in) balls.



VX89A501RAMARM

**RAM short arm, 128 mm (5 in)**  
for "D"- size 57.15 mm (2.25 in) balls.

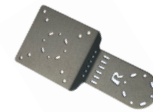

RT10-KEYBD-PLATE

**Keyboard adapter** for vehicle dock installations. Attaches to vehicle.

# VEHICLE MOUNT KITS

RT10-2012BRKTKIT

## RAM Mount kit, Round base

For mounting to RT10 vehicle docks. Keyboard and dock not included. Screws and washers included.



**1. D-Ball round base**  
VX89A030RAMBALL  
D-Size Round Ball



**2. Medium arm D-size**  
VX89A501RAMARM D-Size Med Arm



**3. D-Ball w/VESA plate**  
RT10-MNT-RAM D-Size Ball



**4. Plate**  
RT10-KEYBD-PLATE



**5. C-Ball**  
VC89A041RAMBALL  
C-Size Round Ball



**6. Medium arm C-size**  
VX89A504RAMARM C-Size Med Arm



**7. C-Ball w/Keybrd Plate**  
9000029BRACKET C-Size Round Ball

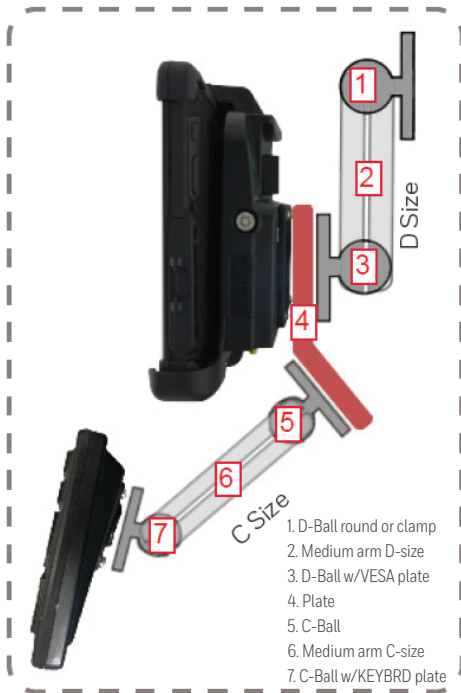

RT10-2015BRKTKIT

## RAM Mount kit, Clamp base

For mounting to RT10 vehicle docks. Keyboard and dock not included. Screws and washers included.



**1. D-Ball Clamp base**  
VX89A031RAMBALL  
D-Size Clamp Ball



**2. Medium arm D-size**  
VX89A501RAMARM D-Size Med Arm



**3. D-Ball w/VESA plate**  
RT10-MNT-RAM D-Size Ball



**4. Plate**  
RT10-KEYBD-PLATE



**5. C-Ball**  
VC89A041RAMBALL  
C-Size Round Ball



**6. Medium arm C-size**  
VX89A504RAMARM C-Size Med Arm



**7. C-Ball w/Keybrd Plate**  
9000029BRACKET C-Size Round Ball

**For more information**

[www.honeywellaidc.com](http://www.honeywellaidc.com)

**Honeywell Safety and  
Productivity Solutions**

300 S Tryon St Suite 500

Charlotte, NC 28202

877-841-2840

[www.honeywell.com](http://www.honeywell.com)

RT10 Series Rugged Tablet Accessories Guide | Rev B | 04/21  
© 2021 Honeywell International Inc.

**Honeywell**